

REVISED	DATE	BY
Y	10-22-19	AVS

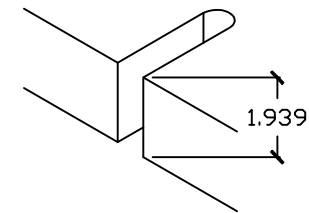
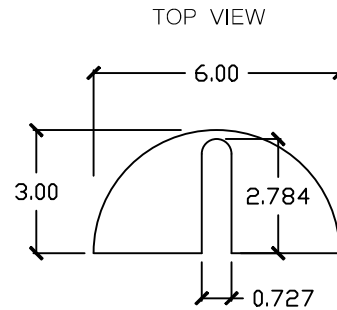
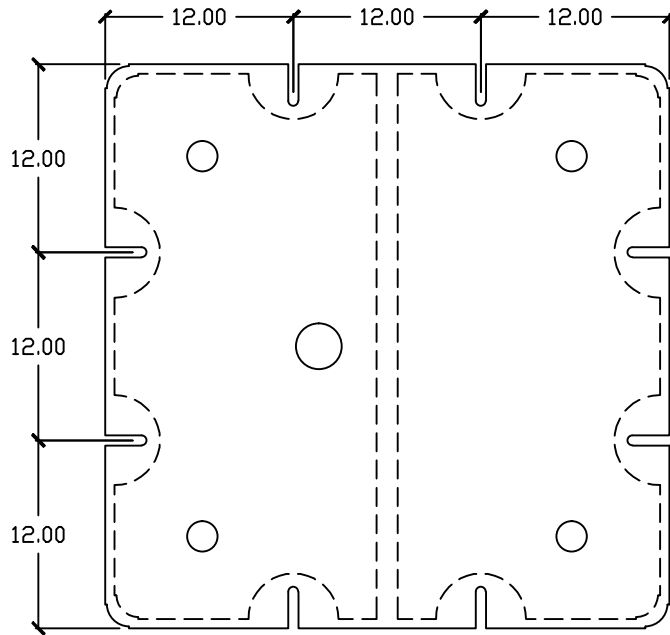
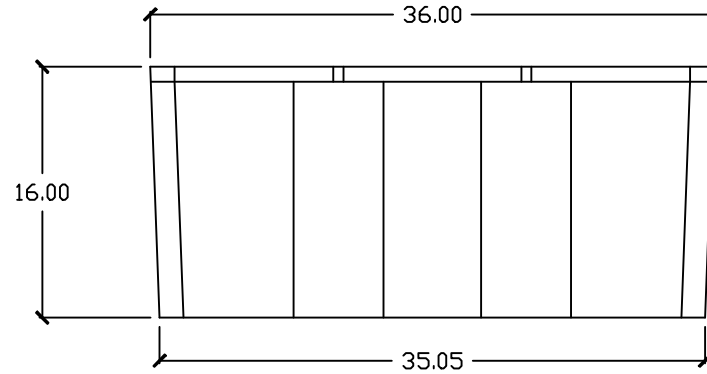
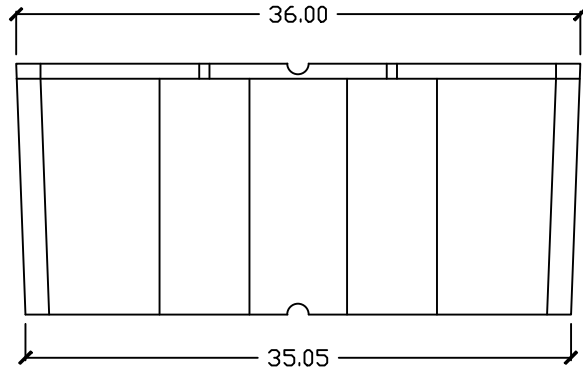

Common technical specs.	
Max buoyancy :	620 LB'S
Nominal wall thickness :	0.15"
Cubic feet:	10.75 FT ³
Weight:	39.0 LB.'s
HENDREN PLASTICS INC.	
1607 HWY 72 SE Gravette AR 72736	
DRAWN BY JEB	APPROVED BY AVS
DATE: 11-11-2014	
Materials: Polyethylene encasing Expanded Foam	
Part Name: 3'x3'x16" Eagle Float	
AutoCad 2010	PART # : EF3316
1 of 1	

As with all types of materials, allowances must be made for shrinkage and changing of exact dimensions due to temperature and other conditions.

CONFIDENTIALITY NOTICE: This drawing is the sole property of Hendren Plastics Inc. It is intended only for the use of the individual or entity whose name appears on this drawing. Any unauthorized review, use, disclosure, or distribution is strictly prohibited.

NOT TO SCALE