

REVISED	DATE	BY
Y	11-22-19	AVS

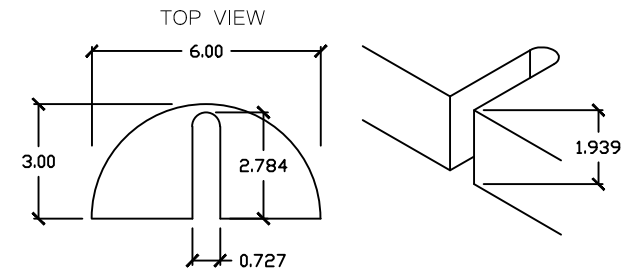
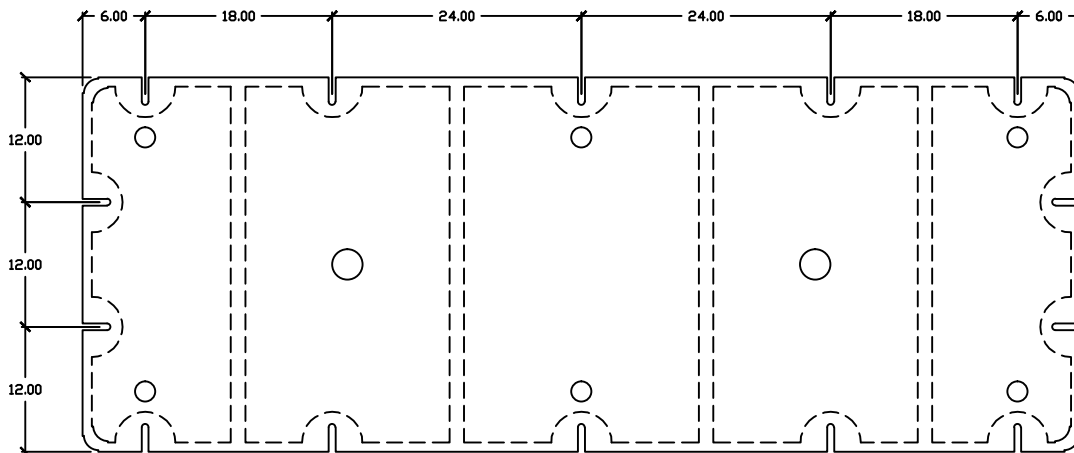
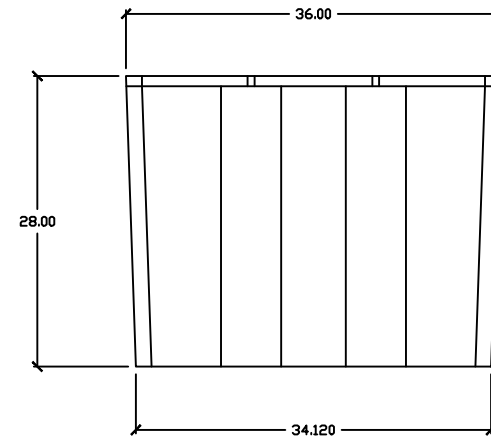
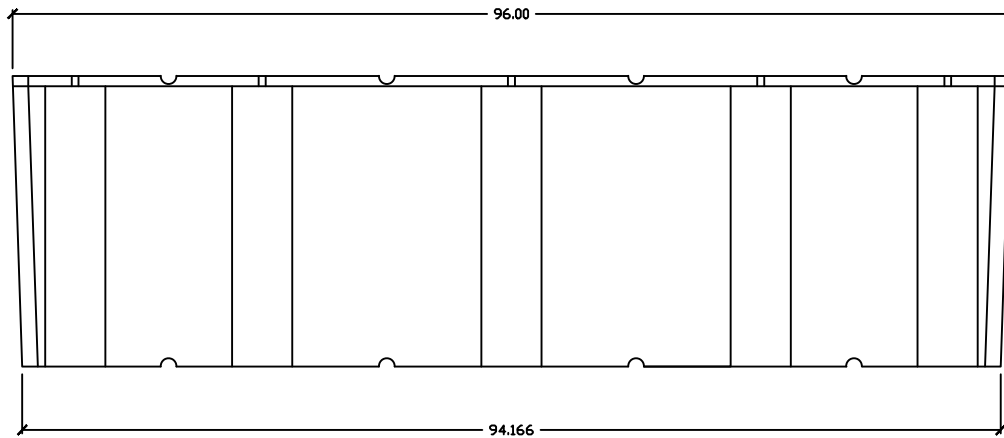

Common technical specs.	
Max buoyancy :	2880 LB'S
Nominal wall thickness :	0.15"
Cubic feet:	51.11 FT <sup>3</sup>
Weight:	127.0 LB.'s

HENDREN PLASTICS INC.  
1607 HWY 72 SE Gravette AR 72736

DRAWN BY: JEB APPROVED BY: AVS DATE: 06-19-2014

Materials: Polyethylene encasing  
Expanded Foam

Part Name: 3'x8'x28" Eagle Float

AutoCad 2010 PART # : EF3828 1 of 1

As with all types of materials, allowances must be made for shrinkage and changing of exact dimensions due to temperature and other conditions.

CONFIDENTIALITY NOTICE: This drawing is the sole property of Hendren Plastics Inc. It is intended only for the use of the individual or entity whose name appears on this drawing. Any unauthorized review, use, disclosure, or distribution is strictly prohibited.

NOT TO SCALE